

Evaluating Oscilloscope Fundamentals

Application Note

This application note provides an overview of oscilloscope fundamentals. You will learn what an oscilloscope is and how it operates. We will discuss oscilloscope applications and give you an overview of basic measurements and performance characteristics. We will also look at the different types of probes and discuss their advantages and disadvantages.

Table of Contents

Introduction	1
Electronic Signals	2
Wave properties	2
Waveforms	3
Analog versus digital signals	4
What is an Oscilloscope and Why Do You Need One?	5
Signal integrity	5
What an oscilloscope looks like	6
An oscilloscope's purpose	7
Types of oscilloscopes	8
Where oscilloscopes are used	10
Basic Oscilloscope Controls and Measurements	11
Basic front-panel controls	11
Softkeys	14
Basic measurements	15
Basic mathematical functions	16
Important Oscilloscope Performance Characteristics	17
Bandwidth	17
Channels	17
Sample rate	18
Memory depth	19
Update rate	20
Oscilloscope connectivity	20
Oscilloscope Probes	21
Loading	21
Passive probes	21
Active probes	21
Current probes	22
Probe accessories	22
Conclusion	23

Introduction

Electronic technology permeates our lives. Millions of people use electronic devices such as cell phones, televisions, and computers on a daily basis. As electronic technology has advanced, the speeds at which these devices operate have accelerated. Today, most devices use high-speed digital technologies.

Engineers need the ability to accurately design and test the components in their high-speed digital devices. The instrumentation engineers use to design and test their components must be particularly well-suited to deal with high speeds and high frequencies. An oscilloscope is an example of just such an instrument.

Oscilloscopes are powerful tools that are useful for designing and testing electronic devices. They are vital in determining which components of a system are behaving correctly and



which are malfunctioning. They can also help you determine whether or not a newly designed component behaves the way you intended. Oscilloscopes are far more powerful than multimeters because they allow you to see what the electronic signals actually look like.

Oscilloscopes are used in a wide range of fields, from the automotive industry to university research laboratories, to the aerospace-defense industry. Companies rely on oscilloscopes to help them uncover defects and produce fully-functional products.



Electronic Signals

The main purpose of an oscilloscope is to display electronic signals. By viewing signals displayed on an oscilloscope you can determine whether a component of an electronic system is behaving properly. So, to understand how an oscilloscope operates, it is important to understand basic signal theory.

Wave properties

Electronic signals are waves or pulses. Basic properties of waves include:

Amplitude

Two main definitions for amplitude are commonly used in engineering applications. The first is often referred to as the peak amplitude and is defined as the magnitude of the maximum displacement of a disturbance. The

second is called the root-mean-square (RMS) amplitude. To calculate the RMS voltage of a waveform, square the waveform, find its average voltage and take the square root.

For a sine wave, the RMS amplitude is equal to 0.707 times the peak amplitude.

Phase shift

Phase shift refers to the amount of horizontal translation between two otherwise identical waves. It is measured in degrees or radians. For a sine wave, one cycle is represented by 360 degrees. Therefore, if two sine waves differ by half of a cycle, their relative phase shift is 180 degrees.

Period

The period of a wave is simply the amount of time it takes for a wave to repeat itself. It is measured in units of seconds.

Frequency

Every periodic wave has a frequency. The frequency is simply the number of times a wave repeats itself within one second (if you are working in units of Hertz). The frequency is also the reciprocal of the period.

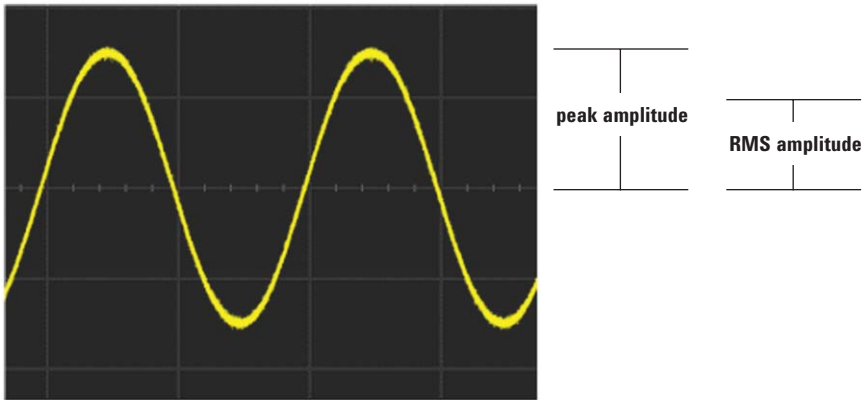

Figure 1. Peak amplitude and RMS amplitude for a sine wave

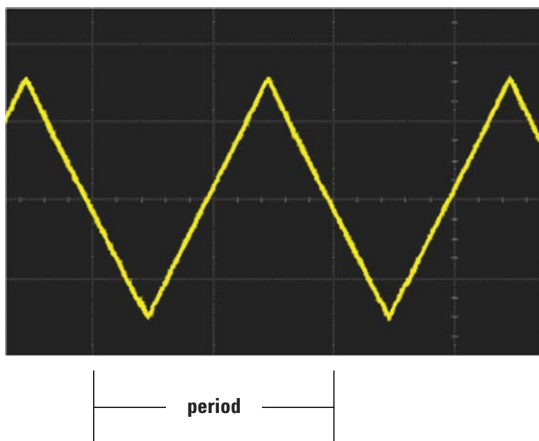

Figure 2. The period of a triangular wave

Electronic Signals (continued)

Waveforms

A waveform is the shape or representation of a wave. Waveforms can provide you with a great deal of information about your signal. For example, it can tell you if the voltage changes suddenly, varies linearly, or remains constant. There are many standard waveforms, but this section will cover the ones you will encounter most frequently.

Sine waves

Sine waves are typically associated with alternating current (AC) sources such as an electrical outlet in your house. A sine wave does not always have a constant peak amplitude. If the peak amplitude continually decreases as time progresses, we call the waveform a damped sine wave.

Square/rectangular waves

A square waveform periodically jumps between two different values such that the lengths of the high and low segments are equivalent. A rectangular waveform differs in that the lengths of the high and low segments are not equal.

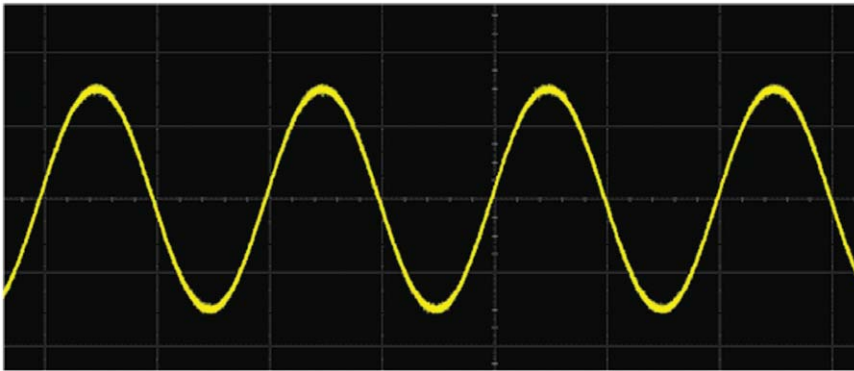

Figure 3. A sine wave

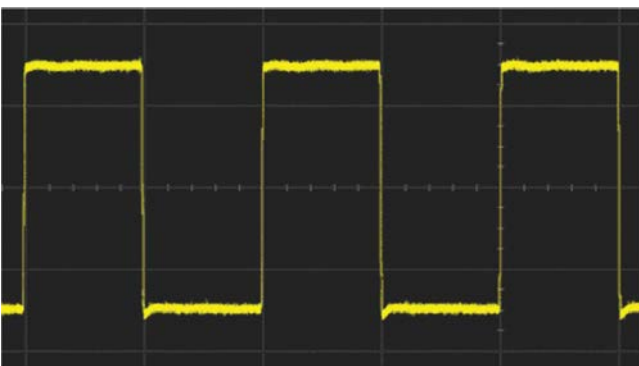

Figure 4. A square wave

Electronic Signals (continued)

Triangular/sawtooth waves

In a triangular wave, the voltage varies linearly with time. The edges are called ramps because the waveform is either ramping up or ramping down to certain voltages. A sawtooth wave looks similar in that either the front or back edge has a linear voltage response with time. However, the opposite edge has an almost immediate drop.

Pulses

A pulse is a sudden single disturbance in an otherwise constant voltage. Imagine flipping the switch to turn the lights on in a room and then quickly turning them off. A series of pulses is called a pulse train. To continue our analogy, this would be like quickly turning the lights on and off over and over again.

Pulses are the common waveform of glitches or errors in your signal. A pulse might also be the waveform if the signal is carrying a single piece of information.

Complex waves

Waves can also be mixtures of the above waveforms. They do not necessarily need to be periodic and can take on very complex wave shapes.

Analog versus digital signals

Analog signals are able to take on any value within some range. It is useful to think of an analog clock. The clock hands spin around the clock face every twelve hours. During this time, the clock hands move continuously. There are no jumps or discreteness in the reading. Now, compare this to a digital clock. A digital clock simply tells you the hour and the minute. It

is, therefore, discretized into minute intervals. One second it might be 11:54 and then it jumps to 11:55 suddenly. Digital signals are likewise discrete and quantized. Typically, discrete signals have two possible values (high or low, 1 or 0, etc.). The signals, therefore, jump back and forth between these two possibilities.

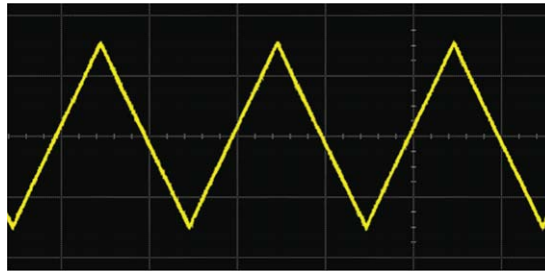

Figure 5. A triangular wave



Figure 6. A sawtooth wave



Figure 7. A pulse

What Is an Oscilloscope and Why Do You Need One?

Signal integrity

The main purpose of an oscilloscope is to give an accurate visual representation of electrical signals. For this reason, signal integrity is very important. Signal integrity refers to the oscilloscope's ability to reconstruct the waveform so that it is an accurate representation of the original signal. An oscilloscope with low signal integrity is useless because it is pointless to perform a test when the waveform on the oscilloscope does not have the same shape or characteristics as the true signal. It is,

however, important to remember that the waveform on an oscilloscope will never be an exact representation of the true signal, no matter how good the oscilloscope is. This is because when you connect an oscilloscope to a circuit, the oscilloscope becomes part of the circuit. In other words, there are some loading effects. Instrument makers strive to minimize loading effects, but they always exist to some degree.

What Is an Oscilloscope and Why Do You Need One? (continued)

What an oscilloscope looks like

In general, modern digitizing oscilloscopes look similar to the one seen in Figure 8. However, there are a wide variety of oscilloscope types, and yours may look very different. Despite this, there are some basic features that most oscilloscopes have. The front panel of most oscilloscopes can be divided into several basic sections: the channel inputs, the display, the horizontal controls, the vertical controls, and the trigger controls. If your oscilloscope does not have a Microsoft® Windows®-based operating system, it will probably have a set of softkeys to control on-screen menus.

You send your signals into the oscilloscope via the channel inputs, which are connectors for plugging in your probes. The display is simply the screen where these signals are displayed. The horizontal and vertical control sections have knobs and buttons that control the horizontal axis (which typically represents time) and vertical axis (which represents voltage) of the signals on the screen display. The trigger controls allow you to tell the oscilloscope under what conditions you want the timebase to start an acquisition.

An example of what the back panel of an oscilloscope looks like is seen in Figure 9.

As you can see, many oscilloscopes have the connectivity features found on personal computers. Examples include CD-ROM drives, CD-RW drives, DVD-RW drives, USB ports, serial ports, and external monitor, mouse, and keyboard inputs.

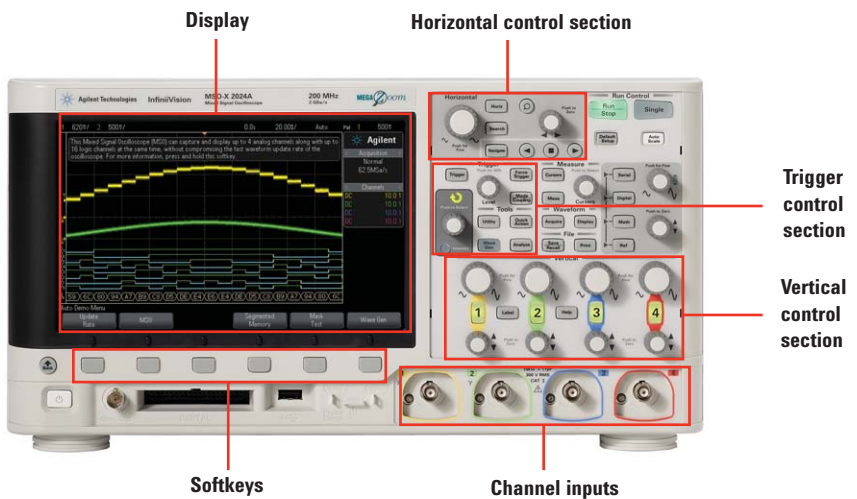

Figure 8. Front panel on the Agilent InfiniVision 2000 X-Series oscilloscope



Figure 9. Rear panel on the Agilent Infiniium 9000 Series oscilloscope

What Is an Oscilloscope and Why Do You Need One? (continued)

An oscilloscope's purpose

An oscilloscope is a measurement and testing instrument used to display a certain variable as a function of another. For example, it can plot on its display a graph of voltage (y-axis) versus time (x-axis). Figure 10 shows an example of such a plot. This is useful if you want to test a certain electronic component to see if it is behaving properly. If you know what the waveform of the signal should be after exiting the component, you can use an oscilloscope to see if the component is indeed outputting the correct signal. Notice also that

the x and y-axes are broken into divisions by a graticule. The graticule enables you to make measurements by visual estimation, although with modern oscilloscopes, most of these measurements can be made automatically and more accurately by the oscilloscope itself.

An oscilloscope can also do more than plot voltage versus time. An oscilloscope has multiple inputs, called channels, and each one of these acts independently. Therefore, you could connect channel 1 to a certain device and channel 2 to another. The oscilloscope could then plot the

voltage measured by channel 1 versus the voltage measured by channel 2. This mode is called the XY-mode of an oscilloscope. It is useful when graphing I-V plots or Lissajous patterns where the shape of these patterns tells you the phase difference and the frequency ratio between the two signals. Figure 11 shows examples of Lissajous patterns and the phase difference/frequency ratio they represent.



Figure 10. An oscilloscope's voltage versus time display of a square wave



Figure 11. Lissajous patterns

What Is an Oscilloscope and Why Do You Need One? (continued)

Types of oscilloscopes

Analog oscilloscopes

The first oscilloscopes were analog oscilloscopes, which use cathode-ray tubes to display a waveform. Photoluminescent phosphor on the screen illuminates when an electron hits it, and as successive bits of phosphor light up, you can see a representation of the signal. A trigger is needed to make the displayed waveform look stable. When one whole trace of the display is completed, the oscilloscope waits until a specific event occurs (for example, a rising edge that crosses a certain voltage) and then starts the trace again. An untriggered display is unusable because the waveform is not shown as a stable waveform on the display (this is true for DSO and MSO oscilloscopes, which will be discussed below, as well.)

Analog oscilloscopes are useful because the illuminated phosphor does not disappear immediately. You can see several traces of the oscilloscope overlapping each other, which allows you to see glitches or irregularities in the signal. Since the display of the waveform occurs when an electron strikes the screen, the intensity of the displayed signal correlates to the intensity of the actual signal. This

makes the display act as a three-dimensional plot (in other words, x-axis is time, y-axis is voltage, and z-axis is intensity).

The downside of an analog oscilloscope is that it cannot “freeze” the display and keep the waveform for an extended period of time. Once the phosphorus substance deluminates, that part of the signal is lost. Also, you cannot perform measurements on the waveform automatically. Instead you have to make measurements usually using the grid on the display. Analog oscilloscopes are also very limited in the types of signals they can display because there is an upper limit to how fast the horizontal and vertical sweeping of the electron beam can occur. While analog oscilloscopes are still used by many people today, they are not sold very often. Instead, digital oscilloscopes are the modern tool of choice.

Digital storage oscilloscopes (DSOs)

Digital storage oscilloscopes (often referred to as DSOs) were invented to remedy many of the negative aspects of analog oscilloscopes. DSOs input a signal and then digitize it through the use of an analog-to-digital converter. Figure 12 shows an example of one DSO architecture used by Agilent digital oscilloscopes.

The attenuator scales the waveform. The vertical amplifier provides additional scaling while passing the waveform to the analog-to-digital converter (ADC). The ADC samples and digitizes the incoming signal. It then stores this data in memory. The trigger looks for trigger events while the time-base adjusts the time display for the oscilloscope. The microprocessor system performs any additional postprocessing you have specified before the signal is finally displayed on the oscilloscope.

Having the data in digital form enables the oscilloscope to perform a variety of measurements on the waveform. Signals can also be stored indefinitely in memory. The data can be printed or transferred to a computer via a flash drive, LAN, USB, or DVD-RW. In fact, software now allows you to control and monitor your oscilloscope from a computer using a virtual front panel.

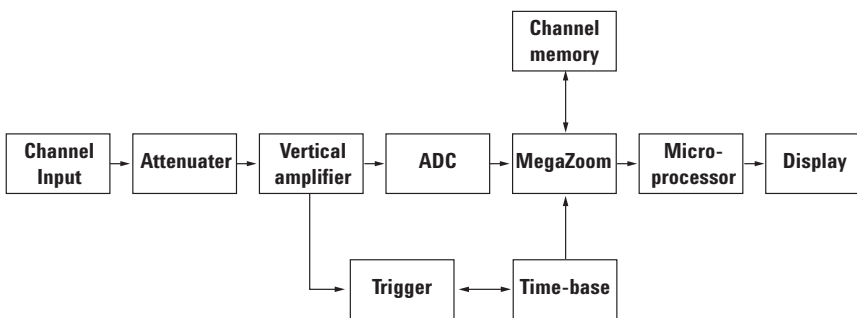

Figure 12. Digitizing oscilloscope architecture

What Is an Oscilloscope and Why Do You Need One? (continued)

Mixed signal oscilloscopes (MSOs)

In a DSO, the input signal is analog and the digital-to-analog converter digitizes it. However, as digital electronic technology expanded, it became increasingly necessary to monitor analog and digital signals simultaneously. As a result, oscilloscope vendors began producing mixed signal oscilloscopes that can trigger on and display both analog and digital signals. Typically there are

a small number of analog channels (2 or 4) and a larger number of digital channels (see Figure 13).

Mixed signal oscilloscopes have the advantage of being able to trigger on a combination of analog and digital signals and display them all, correlated on the same time base.

Portable/handheld oscilloscopes

As its name implies, a portable oscilloscope is one that is small enough to carry around. If you need to move your oscilloscope around to many locations or from bench to bench in your lab, then a portable oscilloscope may be perfect for you. Figure 14 shows an example of a portable instrument, the Agilent InfiniiVision 2000 X-Series oscilloscope.

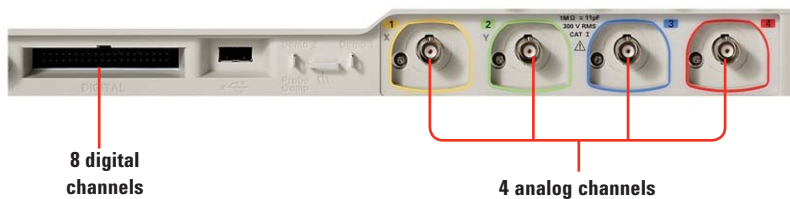

Figure 13. Front panel inputs for the four analog channels and eight digital channels on a mixed-signal oscilloscope

The advantages of portable oscilloscopes are that they are lightweight and portable, they turn on and off quickly, and they are easy to use. They tend to not have as much performance power as larger oscilloscopes, but scopes like the Agilent InfiniiVision 2000 and 3000 X-Series are changing that. These oscilloscopes offer all the portability and ease typically found in portable oscilloscopes, but are also powerful enough to handle most of today's debugging needs up to 500 MHz bandwidth.

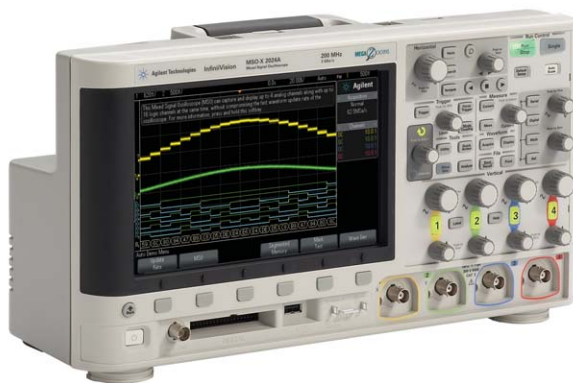

Figure 14. Agilent InfiniiVision 2000 X-Series portable oscilloscope

What Is an Oscilloscope and Why Do You Need One? (continued)

Types of oscilloscopes

Economy oscilloscopes

Economy oscilloscopes are reasonably priced, but they do not have as much performance capability as high-performance oscilloscopes. These oscilloscopes are typically found in university laboratories. The main advantage of these oscilloscopes is their low price. For a relatively modest amount of money, you get a very useful oscilloscope.

High-performance oscilloscopes

High-performance oscilloscopes provide the best performance capabilities available. They are used by people who require high bandwidth, fast sampling and update rates, large memory depth, and a vast array of measurement capabilities. Figure 15 shows an example of a high-performance oscilloscope, the Agilent Infiniium 90000A Series oscilloscope.

The main advantages of a high-performance oscilloscope are that the scope enables you to properly analyze a wide range of signals, and provides many applications and tools that make analyzing current technology simpler and faster. The main disadvantages of high-performance oscilloscopes are their price and size.

Where oscilloscopes are used

If a company is testing or using electronic signals, it is highly likely they have an oscilloscope. For this reason, oscilloscopes are prevalent in a wide variety of fields:

- Automotive technicians use oscilloscopes to diagnose electrical problems in cars.
- University labs use oscilloscopes to teach students about electronics.
- Research groups all over the world have oscilloscopes at their disposal.
- Cell phone manufacturers use oscilloscopes to test the integrity of their signals.
- The military and aviation industries use oscilloscopes to test radar communication systems.
- R&D engineers use oscilloscopes to test and design new technologies.
- Oscilloscopes are also used for compliance testing. Examples include USB and HDMI where the output must meet certain standards.

This is just a small subset of the possible uses of an oscilloscope. It truly is a versatile and powerful instrument.

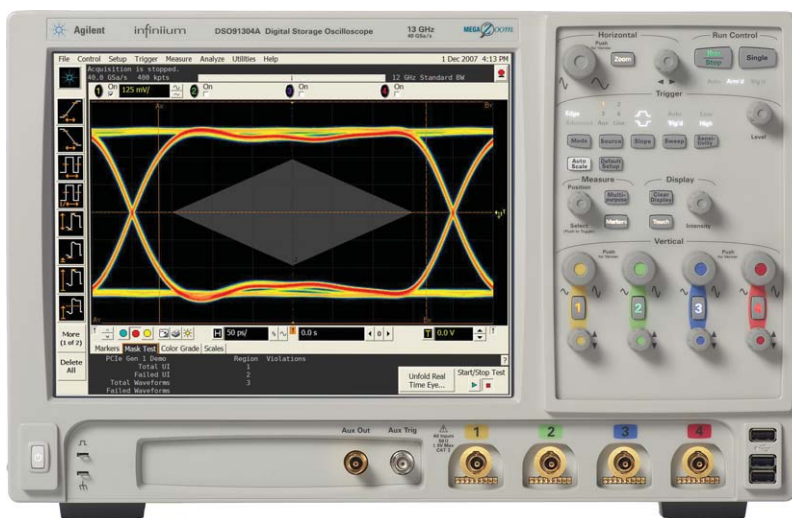

Figure 15. Agilent Infiniium 90000A Series oscilloscope

Basic Oscilloscope Controls and Measurements

Basic front-panel controls

Typically, you operate an oscilloscope using the knobs and buttons on the front panel. In addition to controls found of the front panel, many high-end oscilloscopes now come equipped with operating systems, and as a result, they behave like computers. You can hook up a mouse and keyboard to the oscilloscope and use the mouse to adjust the controls through drop down menus and buttons on the display as well. In addition, some oscilloscopes have touch screens so you can use a stylus or fingertip to access the menus.

Before you begin . . .

When you first sit down at your oscilloscope, check that the input channel you are using is turned on. Then press **[Default Settings]** if there is one. This will return the oscilloscope to its original default state. Then press **[Autoscale]** if there is one. This will automatically set the vertical and horizontal scale such that your waveform can be nicely viewed on the display. Use this as a starting point and then make needed adjustments. If you ever lose track of your waveform or you are having a hard time displaying it, repeat these steps. Most oscilloscope front panels contain at least four main sections: vertical and horizontal controls, triggering controls, and input controls.

Vertical controls

Vertical controls on an oscilloscope typically are grouped in a section marked Vertical. These controls allow you to adjust the vertical aspects of the display. For example, there will be a control that designates the number of volts per division (scale) on the y-axis of the display grid. You can zoom in on a waveform by decreasing the volts per division or you can zoom out by increasing this quantity. There also is a control for the vertical offset of the waveform. This control simply translates the entire waveform up or down on the display. You can see the vertical control section for an Agilent InfiniiVision 2000 X-Series oscilloscope in Figure 16.

Horizontal controls

An oscilloscope's horizontal controls typically are grouped in a front-panel section marked Horizontal. These controls enable you to make adjustments to the horizontal scale of the display. There will be a control that designates the time per division on the x-axis. Again, decreasing the time per division enables you to zoom in on a narrower range of time. There will also be a control for the horizontal delay (offset). This control enables you to scan through a range of time. You can see the horizontal control section for the Agilent InfiniiVision 2000 X-Series oscilloscope in Figure 17.

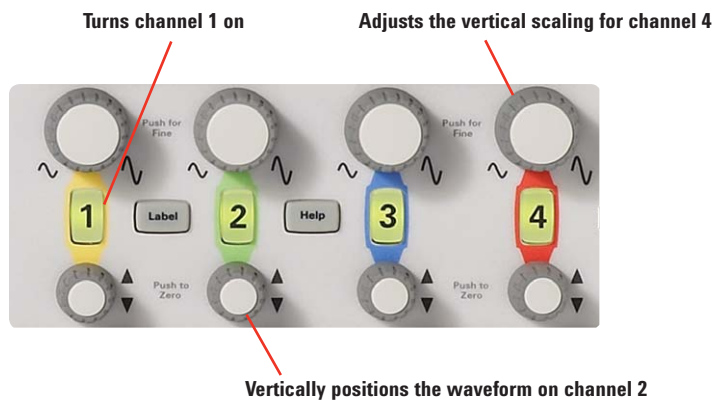

Figure 16. Front panel vertical control section on an Agilent InfiniiVision 2000 X-Series oscilloscope



Figure 17. Front panel horizontal control section on an Agilent InfiniiVision 2000 X-Series oscilloscope

Basic Oscilloscope Controls and Measurements (continued)

Trigger controls

As we mentioned earlier, triggering on your signal helps provide a stable, usable display and allows you to synchronize the scope's acquisition on the part of the waveform you are interested in viewing. The trigger controls let you pick your vertical trigger level (for example, the voltage at which you want your oscilloscope to trigger) and choose between various triggering capabilities. Examples of common triggering types include:

Edge triggering – Edge triggering is the most popular triggering mode. The trigger occurs when the voltage surpasses some set threshold value. You can choose between triggering on a rising or a falling edge. Figure 18 shows a graphical representation of triggering on a rising edge.

Glitch triggering – Glitch triggering mode enables you to trigger on an event or pulse whose width is greater than or less than some specified length of time. This capability is very useful for finding random glitches or errors. If these glitches do not occur very often, it may be very difficult to see them. However, glitch triggering allows you to catch many of these errors. Figure 19 shows a glitch caught by an Agilent InfiniiVision 6000 Series oscilloscope.

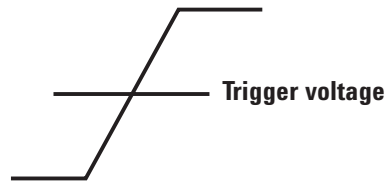

Rising edge triggering

Figure 18. When you trigger on a rising edge, the oscilloscope triggers when the trigger threshold is reached

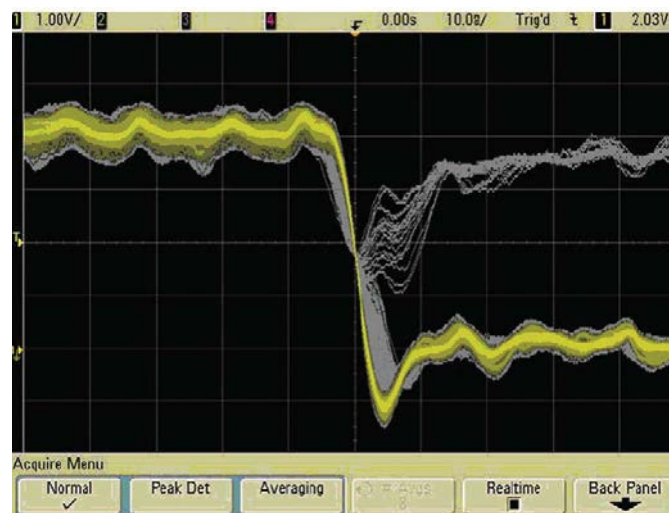

Figure 19. An infrequent glitch caught on an Agilent InfiniiVision 6000 Series oscilloscope

Basic Oscilloscope Controls and Measurements (continued)

Pulse-width triggering – Pulse width triggering is similar to glitch triggering when you are looking for specific pulse widths. However, it is more general in that you can trigger on pulses of any specified width and you can choose the polarity (negative or positive) of the pulses you want to trigger. You can also set the horizontal position of the trigger. This allows you to see what occurred pre-trigger or post-trigger. For instance, you can execute a glitch trigger, find the error, and then look at the signal pre-trigger to see what caused the glitch. If you have the horizontal delay set to zero, your trigger event will be placed in the middle of the screen horizontally. Events that occur right before the trigger will be to the left of the screen and events that occur directly after the trigger will be to the right of the screen. You also can set the coupling of the trigger and set the input source you want to trigger on. You do not always have to trigger on your signal, but can instead trigger a related signal. Figure 20 shows the trigger control section of an oscilloscope's front panel.

Input controls

There are typically two or four analog channels on an oscilloscope. They will be numbered and they will also

usually have a button associated with each particular channel that enables you to turn them on or off. There may also be a selection that allows you to specify AC or DC coupling. If DC coupling is selected, the entire signal will be input. On the other hand, AC coupling blocks the DC component and centers the waveform about 0 volts (ground). In addition, you can specify the probe impedance for each channel through a selection button. The input controls also let you choose the type of sampling. There are two basic ways to sample the signal:

Real-time sampling – Real-time sampling samples the waveform often enough that it captures a complete image of the waveform with each

acquisition. Some of today's higher performance oscilloscopes can capture up to 32-GHz bandwidth signals in a single-shot utilizing real-time sampling

Equivalent-time sampling

– Equivalent time sampling builds up the waveform over several acquisitions. It samples part of the signal on the first acquisition, then another part on the second acquisition, and so on. It then laces all this information together to recreate the waveform. Equivalent time sampling is useful for high-frequency signals that are too fast for real-time sampling (>32 GHz).



Figure 20. Front panel trigger control section on an Agilent InfiniiVision 2000 X-Series oscilloscope

Basic Oscilloscope Controls and Measurements (continued)

Softkeys

Softkeys are found on oscilloscopes that do not have Windows-based operating systems (refer to Figure 8 for a picture of softkeys). These softkeys allow you to navigate the menu system on the oscilloscope's display. Figure 21 shows what a popup menu looks

like when a softkey is pressed. The specific menu shown in the figure is for selecting the trigger mode. You can continually press the softkey to cycle through the choices, or there may be a knob on the front panel that allows you to scroll to your selection.

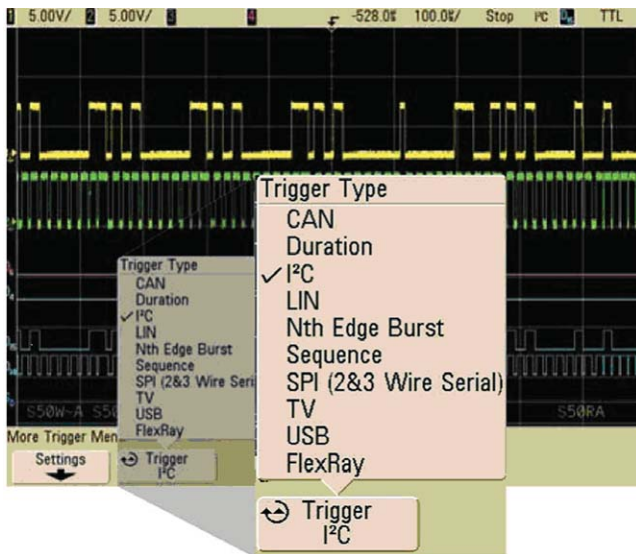

Figure 21. The Trigger Type menu appears when you push the softkey underneath the trigger menu

Basic Oscilloscope Controls and Measurements (continued)

Basic measurements

Digital oscilloscopes allow you to perform a wide range of measurements on your waveform. The complexity and range of measurements available depends on the feature set of your oscilloscope. Figure 22 shows the blank display of an Agilent 8000 Series oscilloscope. Notice the measurement buttons/icons lined up on the far-left side of the screen. Using a mouse, you can drag these icons over to a waveform and the measurement will be computed. They are also convenient because the icons give you an indication of what the measurement computes.

Basic measurements found on many oscilloscopes include:

Peak-to-peak voltage

This measurement calculates the voltage difference between the low voltage and high voltage of a cycle on your waveform.

RMS voltage

This measurement calculates the RMS voltage of your waveform. This quantity can then be used to compute the power.

Risetime

This measurement calculates the amount of time it takes for the signal to go from a low voltage to a high voltage. It is usually calculated by computing the time it takes to go from 10% to 90% of the peak-to-peak voltage.

Pulse width

A positive pulse width measurement computes the width of a pulse by calculating the time it takes for the wave to go from 50% of the peak-to-peak voltage to the maximum voltage and then back to the 50% mark. A

negative pulse width measurement computes the width of a pulse by calculating the time it takes for the wave to go from 50% of the peak-to-peak voltage to the minimum voltage and then back to the 50% mark.

Period

This measurement calculates the period of the waveform.

Frequency

This measurement calculates the frequency of your waveform.

This list is intended to give you an idea of the kinds of measurements available on many oscilloscopes. However, most oscilloscopes can perform many more measurements.



Figure 22. The blank display of an Agilent 8000 Series oscilloscope

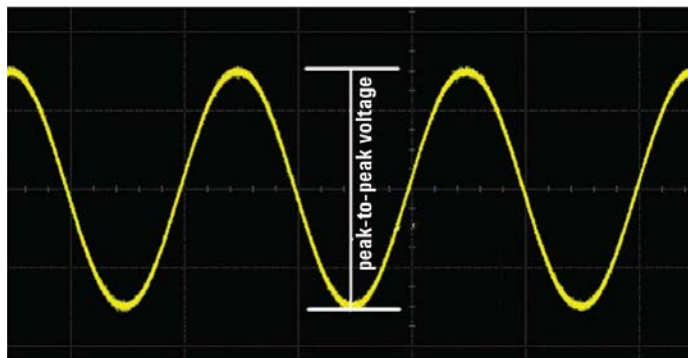

Figure 23. Peak-to-peak voltage

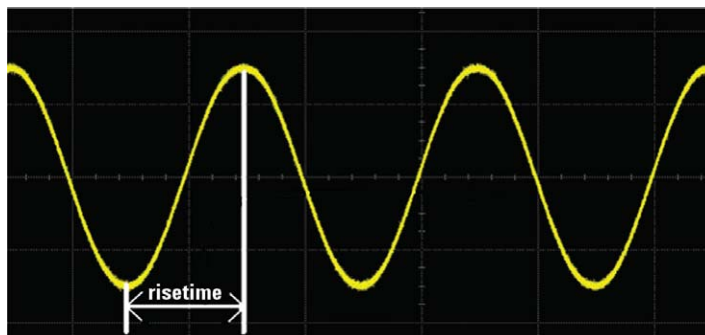

Figure 24. An example of risetime (0% to 100% of peak-to-peak voltage is shown instead of the usual 10% to 90%)

Basic Oscilloscope Controls and Measurements (continued)

Basic mathematical functions

In addition to the measurements discussed above, there are many mathematical operations you can perform on your waveforms. Examples include:

Fourier transform

This math function allows you to see the frequencies that compose your signal.

Absolute value

This math function shows the absolute value (in terms of voltage) of your waveform.

Integration

This math function computes the integral of your waveform.

Addition or subtraction

These math functions enable you to add or subtract multiple waveforms and display the resulting signal.

Again, this is a small subset of the possible measurements and mathematical functions available on an oscilloscope.

Important Oscilloscope Performance Properties

Many oscilloscope properties dramatically affect the instrument's performance and, in turn, your ability to accurately test devices. This section covers the most fundamental of these properties. It also will familiarize you with oscilloscope terminology and describe how to make an informed decision about which oscilloscope will best suit your needs.

Bandwidth

Bandwidth is the single most important characteristic of an oscilloscope, as it gives you an indication of its range in the frequency domain. In other words, it dictates the range of signals (in terms of frequency) that you are able to accurately display and test. Bandwidth is measured in Hertz. Without sufficient bandwidth, your oscilloscope will not display an accurate representation of the actual signal. For example, the amplitude of the signal may be incorrect, edges may not be clean, and waveform details may be lost. The bandwidth of an oscilloscope is the lowest frequency at which an input signal is attenuated by 3 dB. Another way to look at bandwidth: If you input a pure sine wave into the oscilloscope, the bandwidth will be the minimum frequency where the displayed amplitude is 70.7% of the actual signal amplitude.

For details about oscilloscope bandwidth, see application note, *Evaluating Oscilloscope Bandwidths for Your Applications*.

Channels

A channel refers to an independent input to the oscilloscope. The number of oscilloscope channels varies between two and twenty. Most commonly, they have two or four channels. The type of signal a channel carries also varies. Some oscilloscopes have purely analog channels (these instruments are called DSOs – digital signal oscilloscopes). Others, called mixed signal oscilloscopes (MSOs), have a mixture of analog and digital channels. For example, the Agilent InfiniiVision Series MSOs are available with twenty channels, where up to sixteen of them are digital and four are analog.

Ensuring that you have enough channels for your applications is essential. If you have two channels, but you need to display four signals simultaneously, then you obviously have a problem.

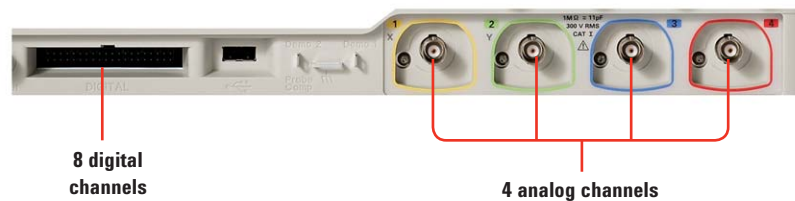

Figure 25. Analog and digital channels on an Agilent MSO 2000 X-Series oscilloscope

Important Oscilloscope Performance Properties (continued)

Sample rate

The sample rate of an oscilloscope is the number of samples the oscilloscope can acquire per second. It is recommended that your oscilloscope have a sample rate that is at least 2.5 times greater than its bandwidth. However, ideally the sample rate should be 3 times the bandwidth or greater.

You need to be careful when you evaluate an oscilloscope's sample rate banner specifications. Manufacturers typically specify the maximum sample rate an oscilloscope can attain, and sometimes this maximum rate is possible only when one or two channels are being used. If more

channels are used simultaneously, the sample rate may decrease. Therefore, it is wise to check how many channels you can use while still maintaining the specified maximum sample rate. If the sample rate of an oscilloscope is too low, the signal you see on the scope may not be very accurate. As an example, assume you are trying to view a waveform, but the sample rate only produces two points per period (Figure 26).

Now consider the same waveform, but with an increased sample rate that samples seven times per period (Figure 27).

It is clear that the greater the samples per second, the more clearly and accurately the waveform is displayed.

If we kept increasing the sample rate for the waveform in this above example, the sampled points would eventually look almost continuous. In fact, oscilloscopes usually use $\sin(x)/x$ interpolation to fill in between the sampled points.

For more information about oscilloscope sampling rates, see application note, *Evaluating Oscilloscope Sample Rates vs. Sampling Fidelity: How to Make the Most Accurate Digital Measurements*.

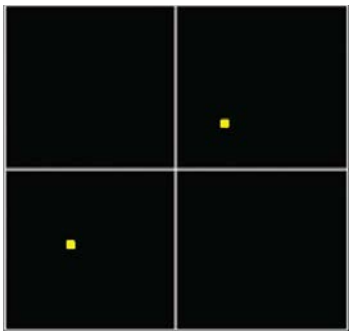

Figure 26. Waveform where the sample rate yields two data points per period

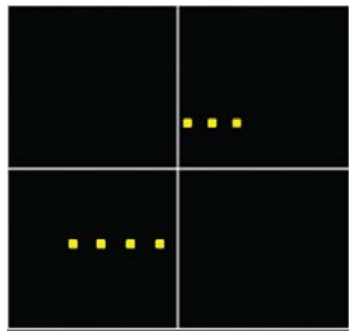

Figure 27. Waveform where the sample rate yields seven data points per period

Important Oscilloscope Performance Properties (continued)

Memory depth

As we mentioned earlier, a digital oscilloscope uses an A/D (analog-to-digital) converter to digitize the input waveform. The digitized data is then stored in the oscilloscope's high-speed memory. Memory depth refers to exactly how many samples or points and, therefore, what length of time can be stored.

Memory depth plays an important role in the sampling rate of an oscilloscope. In an ideal world, the sampling rate would remain constant no matter what the settings were on an oscilloscope. However, this kind of an oscilloscope would require a huge amount of memory at a large time/division setting and would have a price that would severely limit the number of customers that could afford it. Instead, the sampling rate decreases as you increase the range of time. Memory depth is important because the more

memory depth an oscilloscope has, the more time you can spend capturing waveforms at full sampling speed. Mathematically, this can be seen by:

$$\text{Memory depth} = (\text{sample rate})(\text{time across display})$$

So, if you are interested in looking at long periods of time with high resolution between points, you will need deep memory. It is also important to check the responsiveness of the oscilloscope when it is in the deepest memory depth setting. Scopes usually have a severe drop in update rate performance in this mode and, therefore, many engineers only use deep memory when it is essential for their purposes.

To learn more about oscilloscope memory depth, see application note, *Demystifying Deep Memory Oscilloscopes*.

Important Oscilloscope Performance Properties (continued)

Update rate

Update rate refers to the rate at which an oscilloscope can acquire and update the display of a waveform. While it may appear to the human eye that the scope is displaying a “live” waveform, it is because the updates are occurring so fast that the human eye cannot detect the changes. In actuality, there is some dead-time in between acquisitions of the waveform (Figure 28). During this dead-time, a portion of the waveform is not displayed on the oscilloscope. As a result, if some infrequent event or glitch occurs during one of these moments, you will not see it.

It is easy to see why having a fast update rate is important. Faster update rates mean shorter dead-times, which means a higher probability of catching infrequent events or glitches.

Say for example you are displaying a signal that has a glitch which occurs once every 50,000 cycles. If your

oscilloscope has an update rate of 100,000 waveforms per second, then you will capture this glitch twice per second on average. If, however, your oscilloscope has an update rate of 800 waveforms per second, then it would take you one minute on average. This is a long time to be watching.

Update rate specifications need to be read with care. Some manufacturers require special acquisition modes to attain the banner specification update rates. These acquisition modes can severely limit the performance of the oscilloscope in areas such as memory depth, sample rate, and waveform reconstruction. Therefore, it is wise to check the performance of the oscilloscope when it is displaying waveforms with this maximum update rate.

Oscilloscope connectivity

Oscilloscopes come with a wide range of connectivity features. Some are equipped with USB ports, DVD-RW drives, external hard drives, external monitor ports, and much more. All of these features make it easier to use your oscilloscope and transfer data. Some oscilloscopes also come equipped with operating systems that allow your oscilloscope to behave like a personal computer. With an external monitor, a mouse, and a keyboard, you can view your oscilloscope’s display and control your oscilloscope as if it were embedded in your PC’s tower. You can also transfer data from an oscilloscope to a PC via a USB or LAN connection in many instances.

Good connectivity features can save you a great deal of time and make completing your job easier. For instance, it can allow you to quickly and seamlessly transfer data to your laptop or share data with geographically dispersed colleagues. It can also allow you to remotely control your oscilloscope from your PC. In a world where the efficient transfer of data is a requirement in many situations, purchasing an oscilloscope with quality connectivity features is a very good investment.

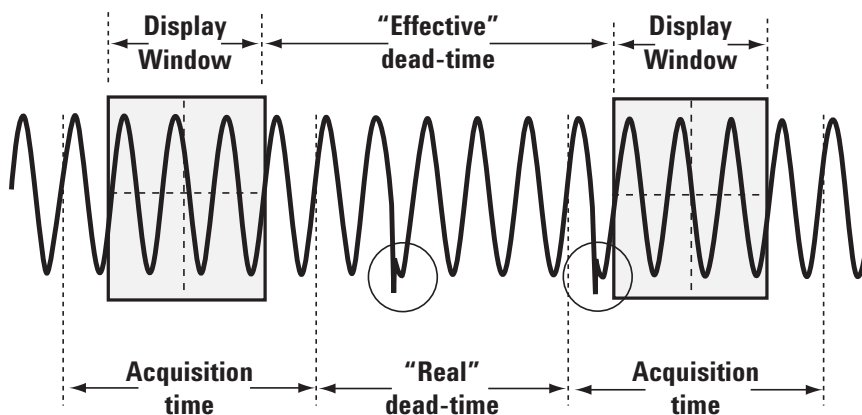

Figure 28. Visual depiction of dead-time. The circles highlight two infrequent events that would not be displayed

Oscilloscope Probes

The oscilloscope is just one piece of the system that determines how accurately you are able to display and analyze your signals. Probes, which are used to connect the oscilloscope to your device under test (DUT), are crucial in terms of signal integrity. If you have a 1-GHz oscilloscope but only have a probe that supports a bandwidth of 500 MHz, you are not fully utilizing the bandwidth of your oscilloscope. This section discusses the types of probes and when you should use each one.

Loading

No probe is able to perfectly reproduce your signal, because when you connect a probe to a circuit, the probe becomes part of that circuit. Part of the electrical energy in the circuit flows through the probe. This phenomenon is called loading. There are three types of loading: resistive, capacitive, and inductive.

Resistive loading—can cause the amplitude of your displayed signal to be incorrect. It can also cause a circuit that is malfunctioning to start working when the probe is attached. It is a good idea to make sure the resistance of your probe is greater than ten times the resistance of the source in order to get an amplitude reduction of less than ten percent.

Capacitive loading—causes rise times to be slowed and bandwidth to be reduced. To reduce capacitive loading, choose a probe with at least five times the bandwidth of your signal.

Inductive loading—appears as ringing in your signal. It occurs because of the inductive effects of the probe ground lead, so use the shortest lead possible.

Passive probes

Passive probes contain only passive components and do not require a power supply for their operation. They are useful for probing signals with bandwidths less than 600 MHz. Once this frequency is surpassed, a different kind of probe is required (an active probe).

Passive probes are typically inexpensive, easy to use, and rugged. They are a versatile and accurate type of probe. Types of passive probes include low-impedance resistor-divider probes, compensated, high-resistance passive divider probes, and high-voltage probes.

Passive probes usually produce relatively high capacitive loading and low resistive loading.



Figure 29. A passive probe

Active probes

To operate an active probe, the probe requires a power supply to power-up active devices within the probe itself. The required power supply is sometimes supported with a USB cable connection, an external “box”, and sometimes it is supplied by the scopes mainframe itself. Active probes use active components to amplify or condition a signal. They are able to support much higher signal bandwidths and are, therefore, the probes of choice for high-performance applications.

Active probes are considerably more expensive than passive probes. Active probes also tend to be less rugged and the probe tip on active probes tend to be heavier. However, they provide the best overall combination of resistive and capacitive loading and allow you to test much higher-frequency signals.

The Agilent InfiniiMax Series probes are high-performance probes. They use a damping resistor in the probe tips to significantly reduce loading effects. They also have very high bandwidths.



Figure 30. An active probe

Oscilloscope Probes (continued)

Current probes

Current probes are used to measure the current flowing through a circuit. They tend to be big and have limited bandwidth (100 MHz).

Probe accessories

Probes also come with a variety of probe tips. There are many different types of probes tips, everything from bulky tips that can wrap around cables to tips the size of several hairs. These tips make it easier for you to access various parts of a circuit or a device under test.



Figure 31. A current probe

Conclusion

Oscilloscopes are a powerful tool in the technological world we currently live. They are used in a wide range of fields and offer many advantages over other measurement and testing devices. After reading this application note, you should have a good feel for oscilloscope fundamentals. Take this knowledge and continue to read more advanced topics so you can make the most of your time with an oscilloscope.

Related literature

Publication title	Publication type	Publication number
<i>Evaluating Oscilloscope Bandwidths for Your Applications</i>	Application note	5989-5733EN
<i>Evaluating Oscilloscope Sample Rates vs. Sampling Fidelity</i>	Application note	5989-5732EN
<i>Demystifying Deep Memory Oscilloscopes</i>	Application note	5989-4501EN
<i>Agilent Technologies Oscilloscopes</i>	Brochure	5989-7650ENUS
<i>Agilent U1600A Series handheld oscilloscope</i>	Data sheet	5989-5576EN
<i>Agilent Technologies InfiniiVision 2000 X-Series oscilloscopes</i>	Data sheet	5990-6618EN
<i>Agilent Technologies InfiniiVision 3000 X-Series oscilloscopes</i>	Data sheet	5990-6619EN
<i>Agilent Technologies InfiniiVision 6000 Series oscilloscopes</i>	Data sheet	5989-2000EN
<i>Agilent Technologies InfiniiVision 6000L Series oscilloscopes</i>	Data sheet	5989-5470EN
<i>Agilent Technologies InfiniiVision 7000 Series oscilloscopes</i>	Data sheet	5989-7736EN
<i>Agilent Technologies Infiniium 9000 Series oscilloscopes</i>	Data sheet	5990-3746EN
<i>Agilent Technologies Infiniium DSO/DSA90000A Series oscilloscopes</i>	Data sheet	5989-7819EN
<i>Agilent Technologies Infiniium DSO/DSA90000X Series oscilloscopes</i>	Data sheet	5990-5271EN
<i>Agilent Technologies 86100D Infiniium DCA-X wide-bandwidth oscilloscopes</i>	Data sheet	5989-5235EN

Learn more about Agilent oscilloscopes at www.agilent.com/find/scopes

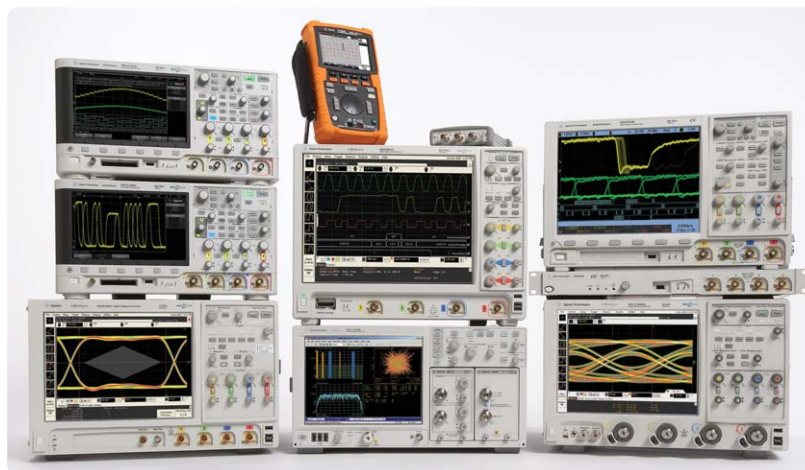

Agilent Technologies Oscilloscopes

Multiple form factors from 20 MHz to >90 GHz | Industry leading specs | Powerful applications

 **Agilent Email Updates**

www.agilent.com/find/emailupdates

Get the latest information on the products and applications you select.

Agilent Channel Partners

www.agilent.com/find/channelpartners

Get the best of both worlds: Agilent's measurement expertise and product breadth, combined with channel partner convenience.



Agilent Advantage Services is committed to your success throughout your equipment's lifetime. We share measurement and service expertise to help you create the products that change our world. To keep you competitive, we continually invest in tools and processes that speed up calibration and repair, reduce your cost of ownership, and move us ahead of your development curve.

www.agilent.com/find/advantageservices



www.agilent.com/quality

For more information on Agilent Technologies' products, applications or services, please contact your local Agilent office. The complete list is available at:

www.agilent.com/find/contactus

Americas

Canada	(877) 894 4414
Brazil	(11) 4197 3500
Mexico	01800 5064 800
United States	(800) 829 4444

Asia Pacific

Australia	1 800 629 485
China	800 810 0189
Hong Kong	800 938 693
India	1 800 112 929
Japan	0120 (421) 345
Korea	080 769 0800
Malaysia	1 800 888 848
Singapore	1 800 375 8100
Taiwan	0800 047 866
Other AP Countries	(65) 375 8100

Europe & Middle East

Belgium	32 (0) 2 404 93 40
Denmark	45 70 13 15 15
Finland	358 (0) 10 855 2100
France	0825 010 700*
	*0.125 €/minute
Germany	49 (0) 7031 464 6333
Ireland	1890 924 204
Israel	972-3-9288-504/544
Italy	39 02 92 60 8484
Netherlands	31 (0) 20 547 2111
Spain	34 (91) 631 3300
Sweden	0200-88 22 55
United Kingdom	44 (0) 118 9276201

For other unlisted Countries:

www.agilent.com/find/contactus

Revised: October 14, 2010

Product specifications and descriptions in this document subject to change without notice.

© Agilent Technologies, Inc. 2011
Printed in USA, February 15, 2011
5989-8064EN

Windows and Microsoft are U.S. registered trademarks of Microsoft Corporation.

